



Digital Adapter Easy Setup Guide

Installation • Operation • Troubleshooting





Table of Contents

What's included in this Install Kit?	4
Connecting to a TVwith HDMI Cable	8
Connecting to a TV with Coax Cable	9
Power Up	10
Connecting to the Network and Activating your Digital Adapter	12
Remote Control Setup Instructions	14
Verify your Services	18
Digital Adapter Operation Guide	19
Remote Operation Guide	21
Troubleshooting Guide	24





What you need to know

To bring you better service now and in the future your cable operator is upgrading to an All-Digital network – All-Digital for every channel, on every TV set.



What you need to do

To continue to receive all the channels you are used to, you will need to make sure that every TV in your home is equipped with one of our Digital Adapter or Digital Cable Boxes.



What's included in this Install Kit?

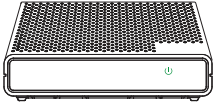

Digital Adapter

Each TV will need to be connected to a Digital Adapter or a Digital Cable Box, but not both.

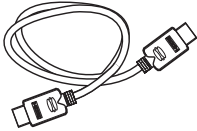

HDMI Cable

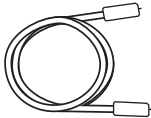

5 Foot Coax Cable

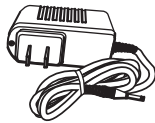

Power Cord

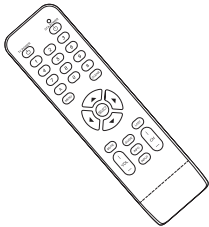

Remote Control

In order to operate the Digital Adapter you must use the remote control included with this kit. Programming instructions for the remote control are included in this guide.



2 AAA Batteries



Adhesive Fasteners

Use these if you want to stick the Digital Adapter to your TV.

Note: Please be careful. Your operator is not responsible for any damage done to any surface you stick these to.



Items that you may also need:

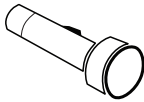

Flashlight



Power Strip

You'll need a power strip if you already have 2 items plugged into the electrical outlet that you plan to use.



Extension Cord

You'll need an extension cord if you already have 2 items plugged into the electrical outlet closest to your TV.







The last four digits of the serial number of each Digital Adapter that you will be activating:

Serial Number	Location in your home	Output Channel
_____	_____	_____
_____	_____	_____
_____	_____	_____
_____	_____	_____
_____	_____	_____
_____	_____	_____

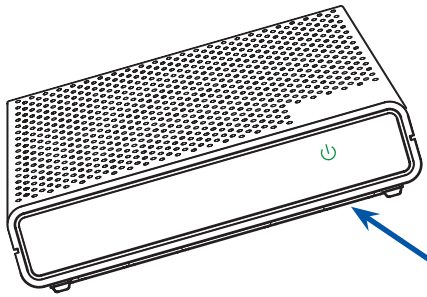

Note: The serial number can be found on the bottom of the Digital Adapter itself and is also printed on the outside of the Digital Adapter package.



Connecting to a TV with HDMI Cable

1

Connect the Digital Adapter to the Cable Outlet

A

Turn off your TV.

B

Locate the cable that currently runs from the cable wall outlet to the back of your TV. Leave one end of the cable connected to the wall, but disconnect the other end from the back of your TV.

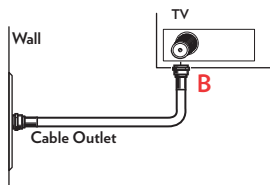

C

Reconnect this end of the cable to the "Cable In" input on the back of the Digital Adapter.

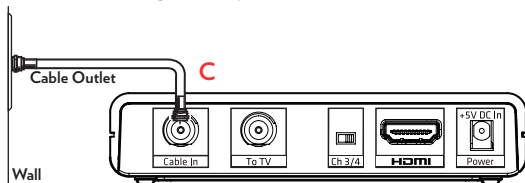

2

Connect the Digital Adapter to the TV

A

Find the HDMI cable included in this kit. Connect one end of the cable to the "HDMI" output on the back of the Digital Adapter.

B

Connect the other end to the "HDMI" input on the back of your TV.

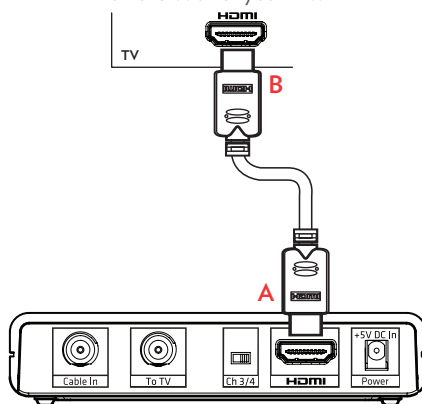

Connecting to a TV with Coax Cable

1

Connect the Digital Adapter to the Cable Outlet

A

Turn off your TV.

B

Locate the cable that currently runs from the cable wall outlet to the back of your TV. Leave one end of the cable connected to the wall, but disconnect the other end from the back of your TV.

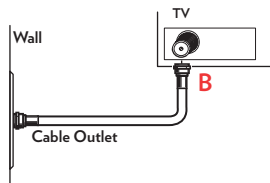

C

Reconnect this end of the cable to the "Cable In" input on the back of the Digital Adapter.

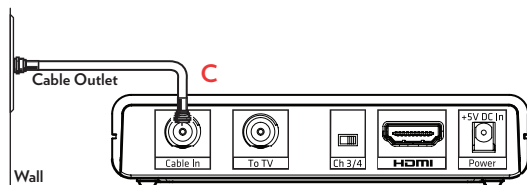

2

Connect the Digital Adapter to the TV

A

Find the 5-foot coax cable included in this kit. Connect one end of the cable to the "To TV" output on the back of the Digital Adapter.

B

Connect the other end to the "Cable In/RF In" input on the back of your TV.

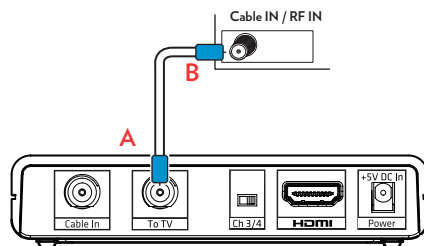

Power Up

A

If you are connecting the Digital Adapter to a television with HDMI, set your TV to choose “HDMI” as the input source.

Or

Pick which output channel your TV will use and make sure your television is set to that selected channel by setting the switch on the back of the Digital Adapter to the proper output channel (*Ch 3 or Ch 4*).

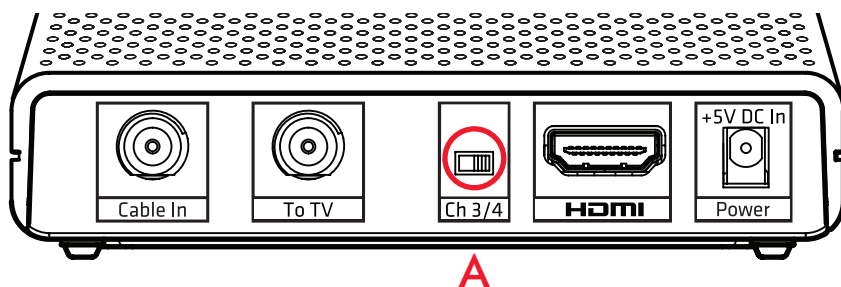

B

Find the power cord included in the kit. Plug the end of the power cord into the power input “+5V DC In” on the back of the Digital Adapter.

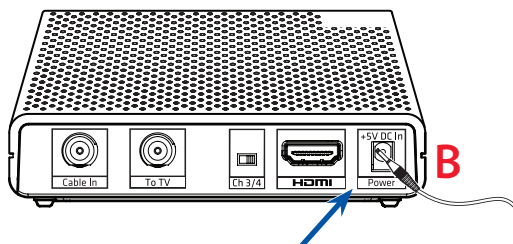



C

Plug the other end into a working electrical outlet or power strip.
Make sure that the outlet is not controlled by a switch that gets turned on and off.

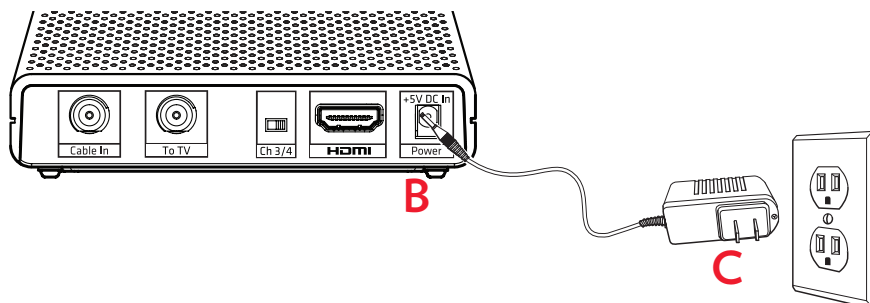

D

Check the front of the Digital Adapter to see if the green light is on and blinking.

If it is not on, check to make sure the power plug was plugged into the power input “+5V DC In” and that the other end is plugged into a working electrical outlet.

Note: After activation, this light will remain on and constantly lit.

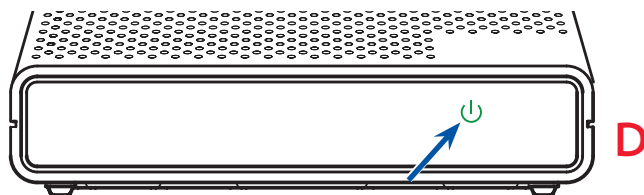

**Please wait 20 minutes before calling to activate.
This will allow the Digital Adapter to connect to
the network and get the latest updates.**



Connecting to the Network and Activating your Digital Adapter

Remember, you must wait 20 minutes before calling to activate. This will allow the Digital Adapter to connect to the network and get the latest updates.

A

If you received more than one Digital Adapter, this would be a good time to get the others installed so you can activate them all with one call.

Note: To complete your activation, you will need your account information and the serial number of each Digital Adapter you are activating.

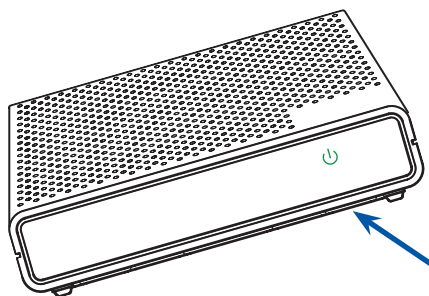

Note: The serial number can be found on the bottom of the Digital Adapter itself and is also printed on the outside of the Digital Adapter package.



B

Call your cable operator's automated activation line and follow the instructions.

C

Turn on your TV and tune it to the proper output channel (*Ch 3 or Ch 4*).

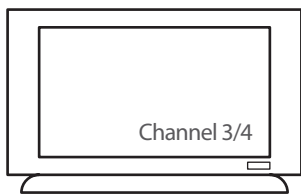



Remote Control Setup Instructions

The RF Remote Control you received with your Digital Adapter Kit must be setup before it will work with your Television and Digital Adapter.

This is a two step process.

First, you must setup the Remote to control the Digital Adapter.

Next you setup the Remote to control the television.

Setup Remote to Control the Digital Adapter

RF Remote Pairing Process:

When multiple remotes work in a shared space, interference can result.

To avoid this problem, the remote must be paired with the Digital Adapter.

Step 1

Turn on your TV using the buttons on the TV or the TV remote.

Make sure power is connected to your Digital Adapter and it is plugged into the TV.

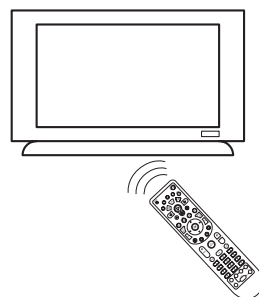

Note: Your TV must always be set to the proper channel (Ch 3 or Ch 4) or HDMI Input to match the output channel on the back of your digital adapter

Step 2

Install the batteries (*included in your kit*) in your new remote control.

Step 3

Make certain no other Digital Adapter remote is in the area.

Make sure power is connected to your Digital Adapter.

Turn on your TV using the buttons on the TV or the TV remote (*not a digital adapter remote in this instance*).



Step 4

Press and hold both **DTA POWER** and **SELECT** keys at the same time.

Once the red light on the remote turns on, then release both keys. Wait 10 seconds, then a 3 digit validation code will display on the TV.

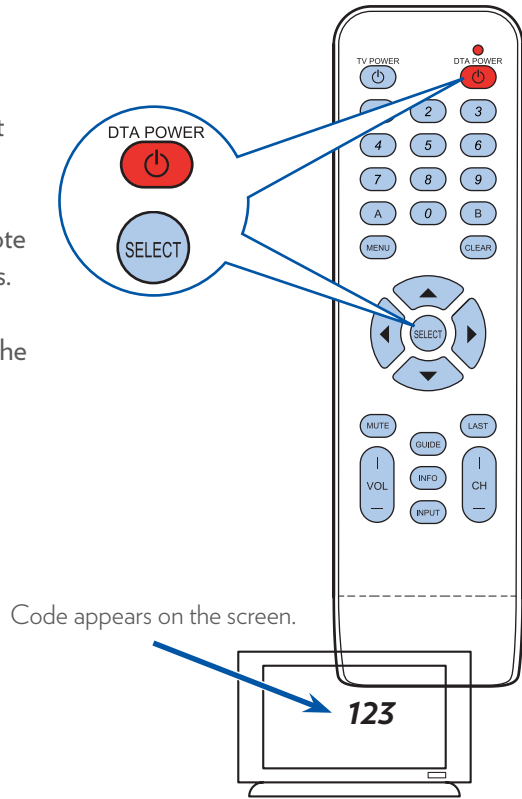

Step 5

Enter the 3 digit code using the Digital Adapter remote. When remote is successfully paired with the digital adapter, the remote's red light will blink twice.

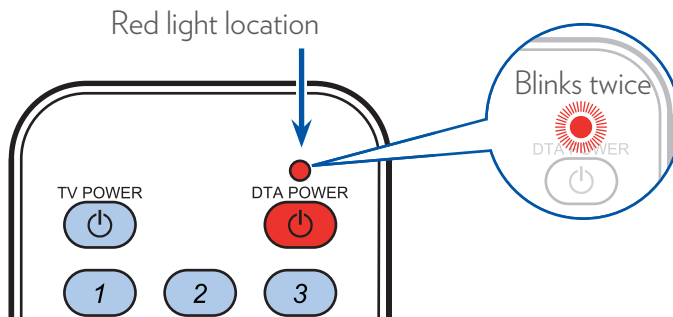

Proceed to next page to setup the Remote Control with your television.

Setup Remote to Control the Television

Step 6

Press and hold both Digit 1 and Digit 3 keys together until the red light turns on. Release both keys.
Keep your eyes on the Remote so you can watch the red light.

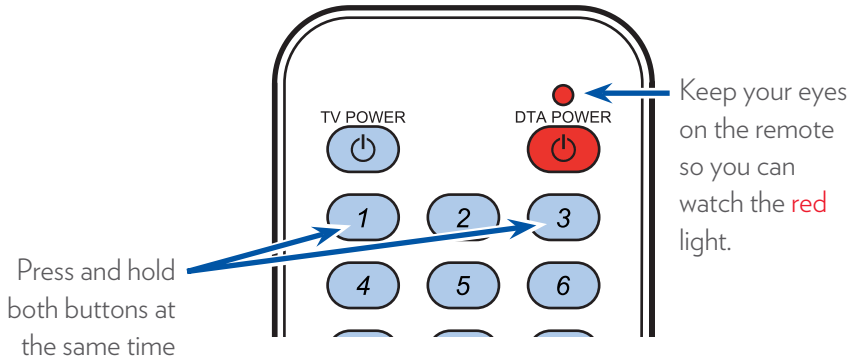

Note: Your TV must always be set to the proper channel (Ch 3 or Ch 4) or HDMI Input to match the output channel on the back of your Digital Adapter.

Step 7

Point the new remote at the TV. Press and hold the **TV POWER** key.

The remote will start searching for the right code while you are holding this key.

When the TV turns off, release the key within 2 seconds to lock in the code.

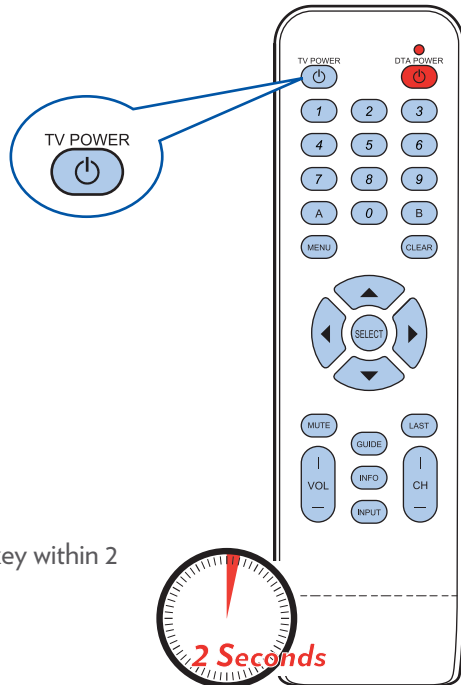

Step 8

Point the new remote at the TV.

Press **TV POWER** on your Remote to turn on your TV.

If your TV responds (*turns on*), then you have successfully programmed your Remote.

The setup of the Remote is now complete.

If you are not successful the first time, try again.

When the Remote Control is programmed to operate the TV, there are 5 keys that control the television:

TV POWER	INPUT
VOLUME +	MUTE
VOLUME -	

Two Remotes

If you were unable to program your remote, you will need to use two remotes to operate your TV:

the Digital Adapter Remote **and** the one that came with your TV.

Setting the Remote Volume

1. Use the remote control that came with your TV to adjust the volume to a comfortable level. This should be the last time you'll use this remote for volume control.
2. Going forward use only your Digital Adapter Remote to adjust volume up or down.

Caution:

Don't use your TV remote to change channels.

Your TV must always be set to the proper

Input, HDMI, Ch 3 or Ch 4

or you will see a snowy or blank screen.

17



Verify your Services

After completing the activation step, wait a few minutes for programming to appear.

A

Confirm that the Digital Adapter is connected to the power and that the light on the front is solid (*not blinking*).

B

Make sure that the TV is on.

C

Use the Digital Adapter's remote control to operate your Digital Adapter. Scroll through your channels to make sure they are all working.

Note: If the light is blinking or your channels are not showing up, turn to the troubleshooting section of this guide.

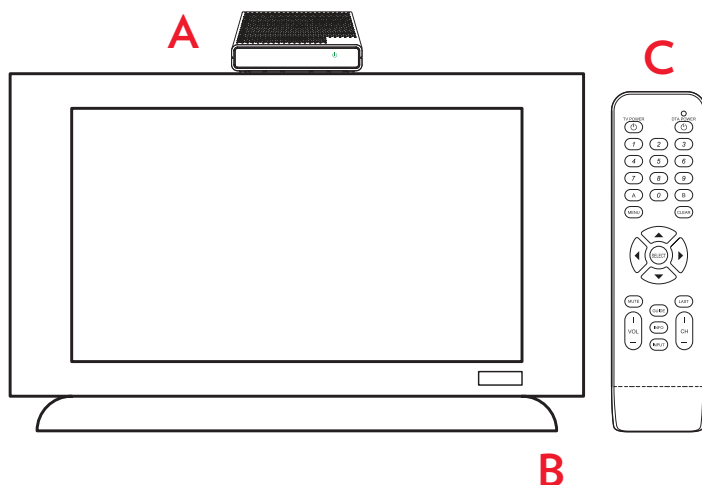



Digital Adapter Operation Guide

Quick Troubleshooting Checklist

- *TV set on the proper output channel (Ch 3 or Ch 4) or HDMI Input*
- *Digital Adapter light is on*

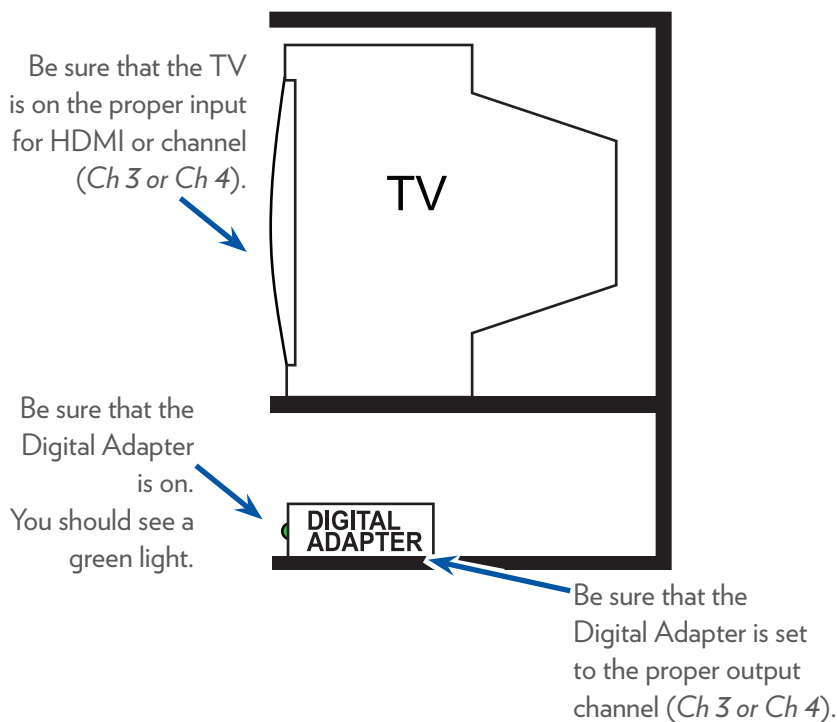

Always use the remote that came with the Digital Adapter to change channels and for volume control.



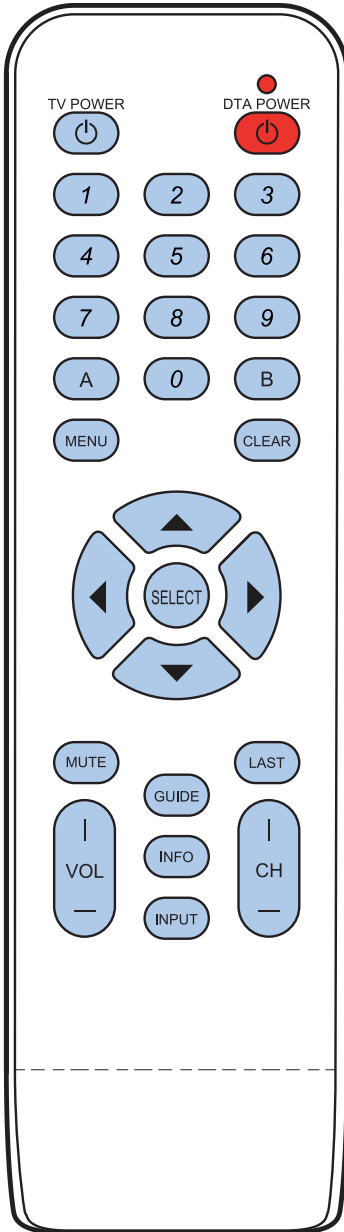









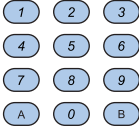

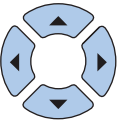

Low Battery Indicator:
The Remote Control will **blink 10 times fast** when the battery is low.
Replace with new batteries at that time.



Remote Operation Guide

KEY	FUNCTION
 <p>TV POWER</p>	<p>When the remote has been programmed to the TV, TV POWER will turn the TV on and off.</p>
 <p>DTA POWER</p>	<p>Use DTA POWER to turn the Digital Adapter on and off. Note: the DTA Power Off feature may not be enabled.</p>
	<p>Use the key pad (0-9) to directly select the channels.</p>
 <p>MENU</p>	<p>Use MENU to display the Menu screen.</p>
 <p>CLEAR</p>	<p>Use CLEAR to erase the last digit you entered.</p>
	<p>Use Navigation Keys to move the cursor UP, DOWN, LEFT, DOWN.</p>
 <p>SELECT</p>	<p>Use SELECT to select the item the cursor is pointing to.</p>
 <p>MUTE</p>	<p>Press MUTE once to turn the sound on or off.</p>

Remote Operation Guide

KEY	FUNCTION
	Use LAST to recall the last channel.
	Use GUIDE to display the Electronic Program Guide. Note: Guide feature may not be offered on your Digital Adapter.
	Use INFO to display information relating to current contents.
	Use INPUT to toggle among TV Input signals.
	Use VOL+ (or VOL-) to raise (or lower) the volume.
	Use CH+ (or CH-) to select the next higher (or lower) channel.

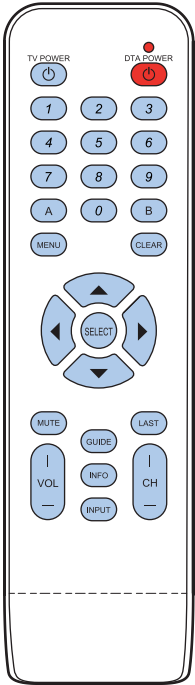

This remote will allow for volume control either through the TV or through the digital adapter. When Volume Punch-through is enabled, the **VOLUME** and **MUTE** keys will control the TV.

Below are the steps required to **disable** Volume Punch-through to the TV.

Step Description

- 1 Press and hold the **MUTE** key and **DTA POWER** key.
- 2 Hold both keys for 3 seconds.
- 3 The red LED on the remote will turn on.
- 4 Release both keys. Volume Punch-through is disabled.

Below are the steps required to **enable** Volume Punch-through to the TV.

Step Description

- 1 Press and hold the **MUTE** key and **TV POWER** key.
- 2 Hold both keys for 3 seconds.
- 3 The red LED on the remote will turn on.
- 4 Release both keys. Volume Punch-through is enabled.



Troubleshooting Guide

If the remote control does not work:

- *Check that the batteries still have charge and are inserted correctly.*

If there is no picture on the TV and the light on the Digital Adapter is blinking:

- *Check your cables and make sure that they are attached correctly.*
- *Unplug the Digital Adapter, plug it back in, then wait 5 minutes for it to reset.*

If there is no picture on the TV and the light on the Digital Adapter is on (*not blinking*):

- *Check that the TV is tuned to the proper channel (Ch 3 or Ch 4).*
- *If you are also connected to a VCR, try turning the VCR off.*
- *Check that the Digital Adapter is connected directly to the cable provider outlet in your wall.*
- *Make sure that all cables are firmly connected.*
- *Check the input setting on your TV, make sure that it is set on HDMI, ANT or CABLE.*





If the remote is turning the TV off and on and changing the channels but not changing the volume:

- *Your TV volume may have been turned all the way down or muted with the old TV remote. .*

If your Digital Adapter is not coming on:

- *Make sure that the power cord is securely connected to the back of the Digital Adapter.*
- *Make sure that the Digital Adapter power cord is plugged into a working power outlet.*

If you cannot get the Digital Adapter remote programmed to your TV:

- *You may not be holding "POWER" long enough (up to 2 minutes).*
- *Be sure to release the "POWER" button within 2 seconds once your TV turns off.*

VCR is not recording the right channel:

- *The VCR will only record the channel that the Digital Adapter is tuned to. Set your TV and VCR to the proper channel (Ch 3 or Ch 4), then use the Digital Adapter remote to tune the Digital Adapter to the channel to be recorded.*



